

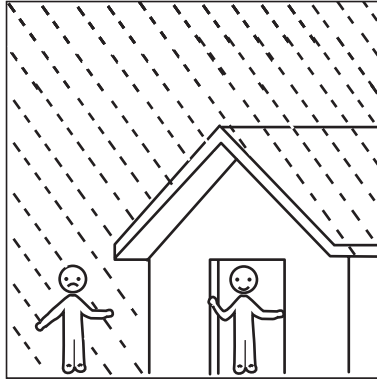

216 Verbes en image



aboyer



s'abriter



accuser, incriminer

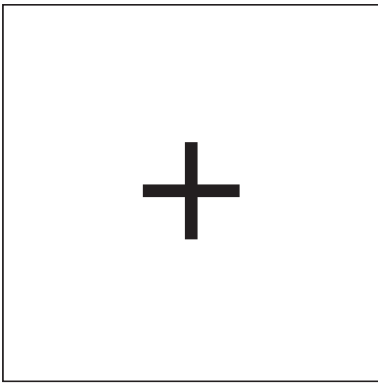

addition - ajouter



aimer



alerter

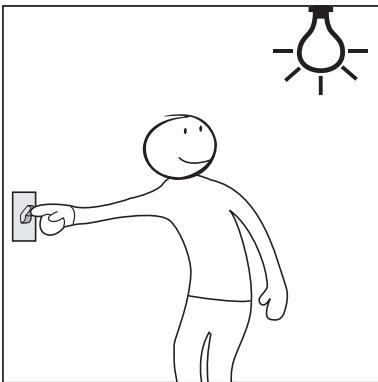

allumer



apercevoir, voir



apparaître

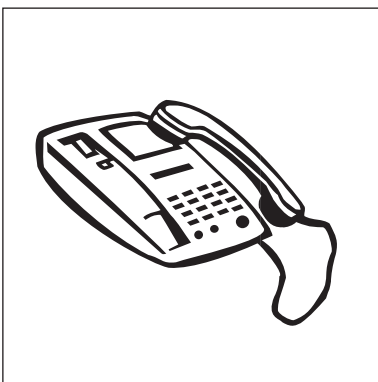

appeler

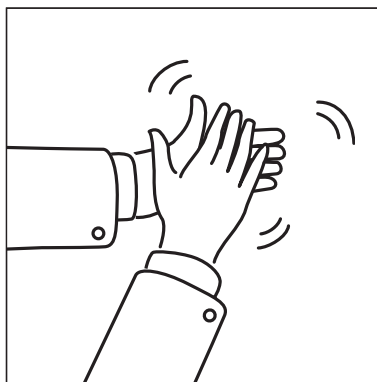

applaudir

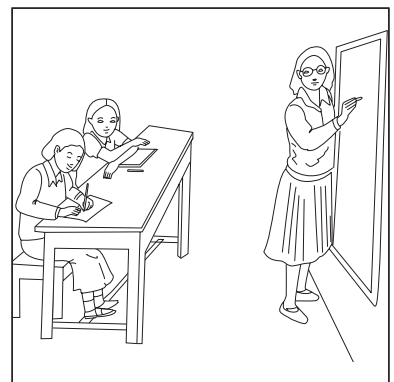

apprendre

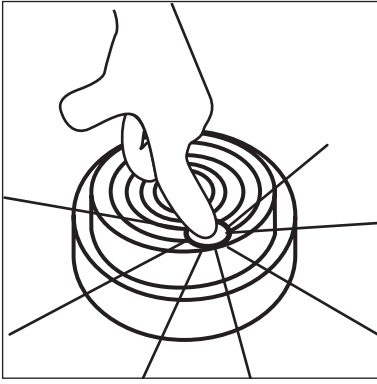

appuyer, toucher



arriver



arroser



asseoir



attacher

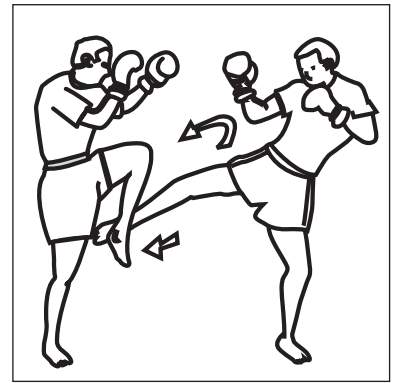

attaquer

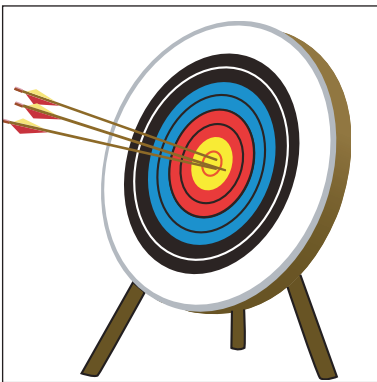

atteindre

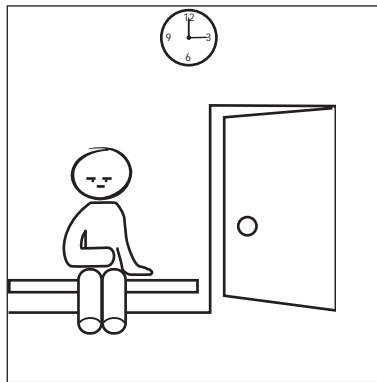

attendre



attrapper

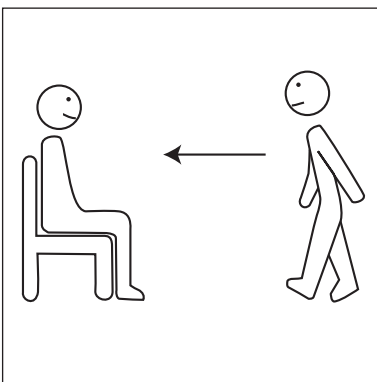

avancer

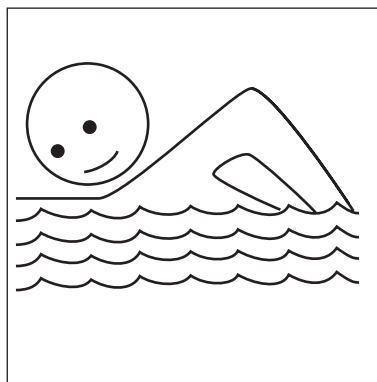

baigner, nager

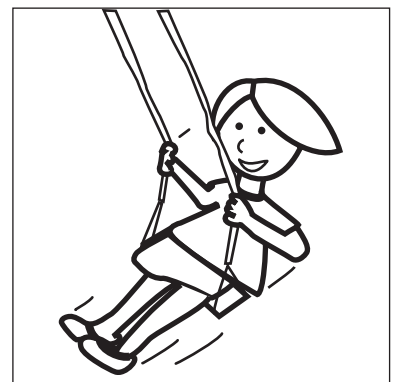

balancer

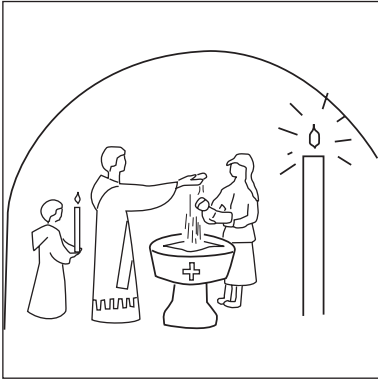

baptiser

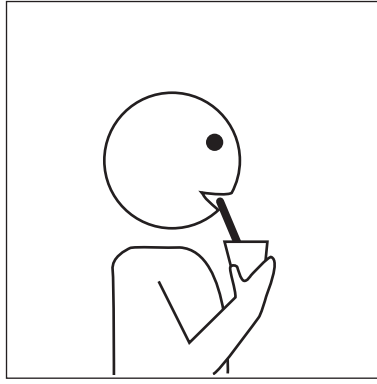

boire



bouder



bouger



bouillir



bricoler, réparer

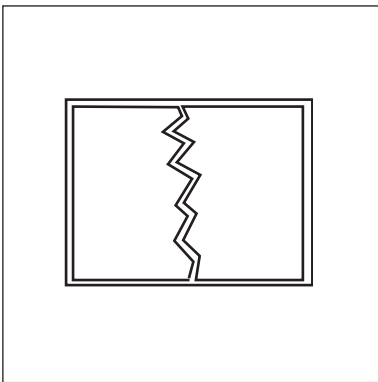

briser

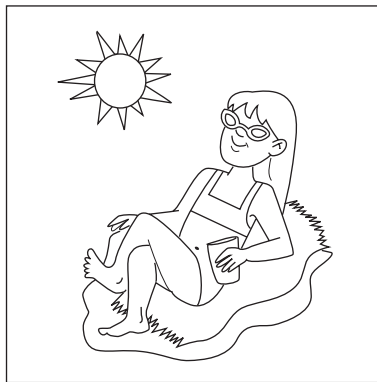

bronzer

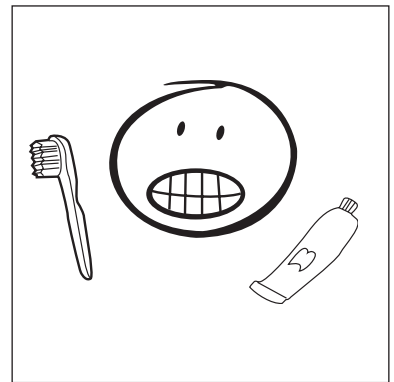

brosser



brûler

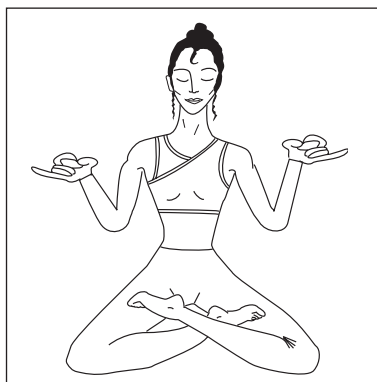

calmer



camper

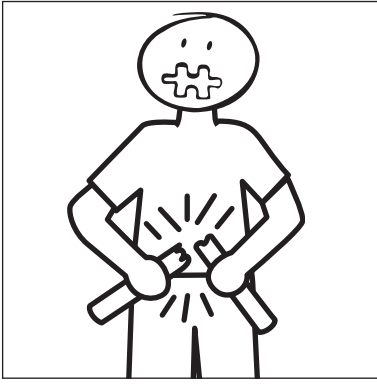

casser

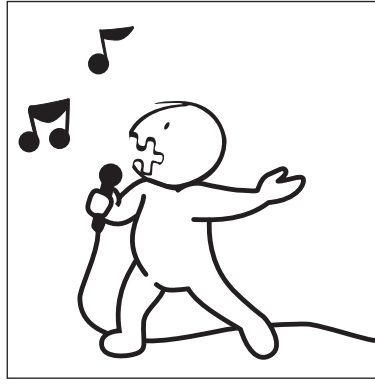

chanter



chauffer



chercher



choisir

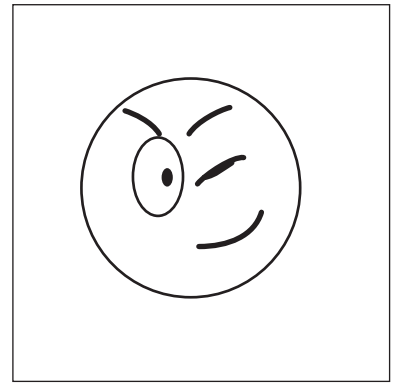

cligner

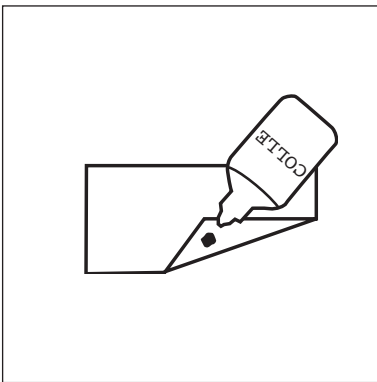

coller



colorier

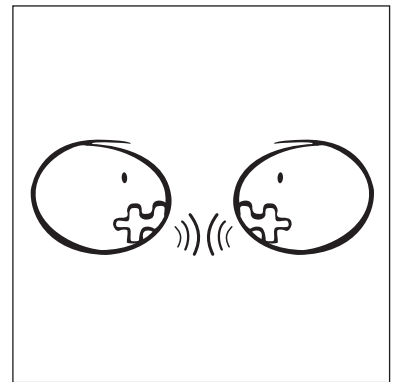

communiquer



composer

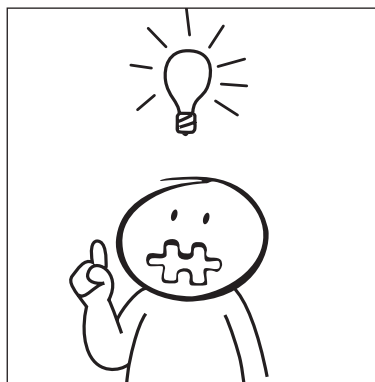

comprendre



concentrer

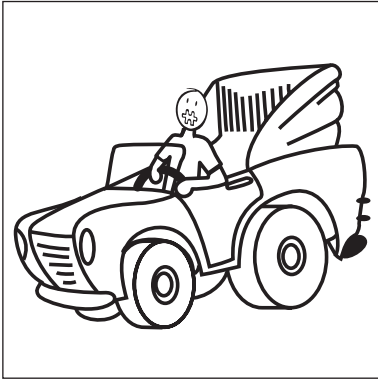

conduire

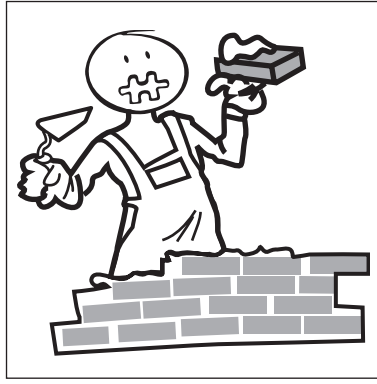

construire

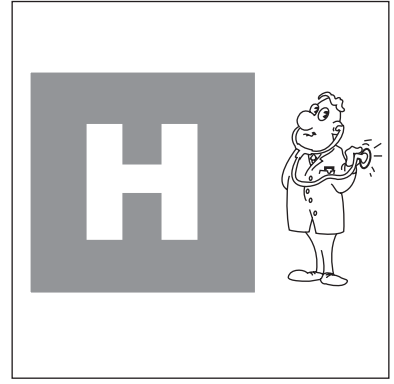

consulter

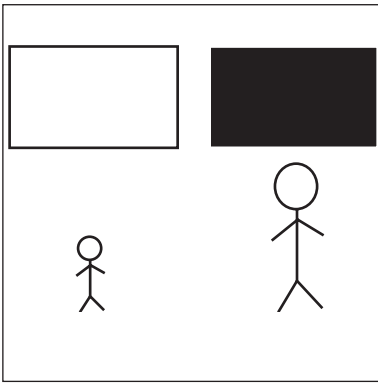

contraire



controler

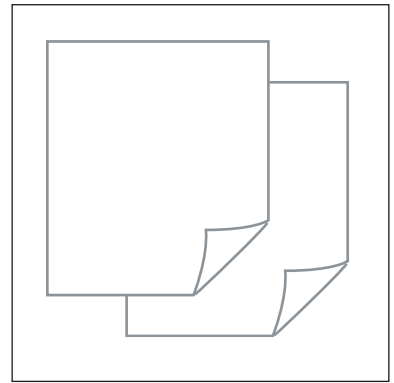

copier

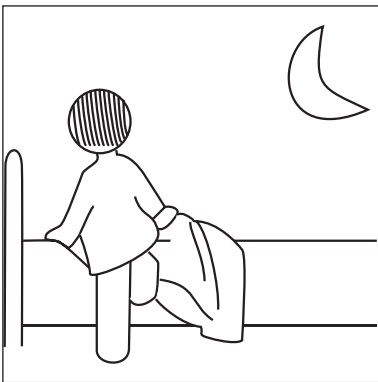

coucher

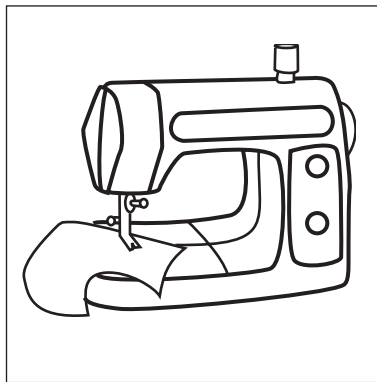

coudre

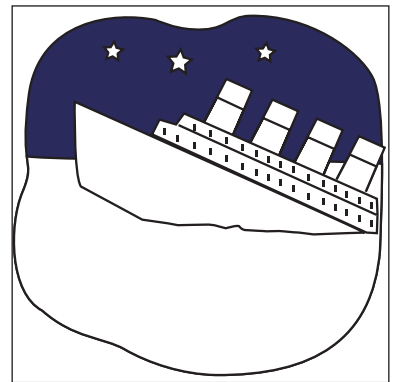

couler

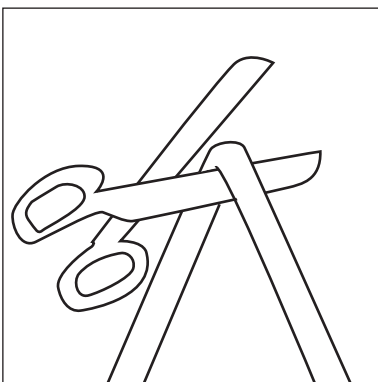

couper

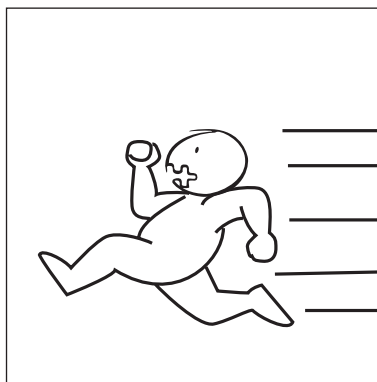

courir



cracher

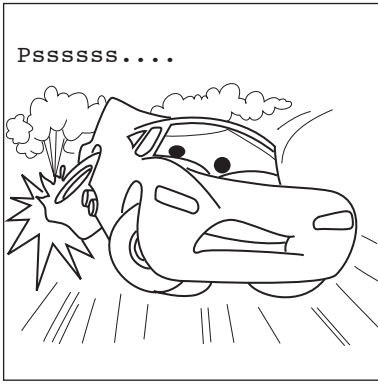

crever



crier

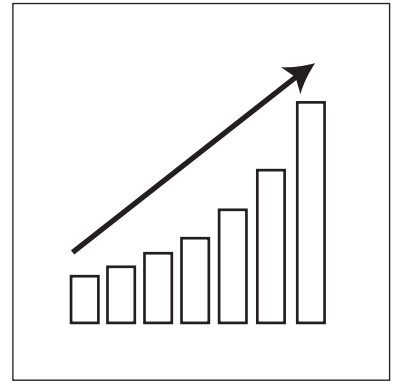

croitre

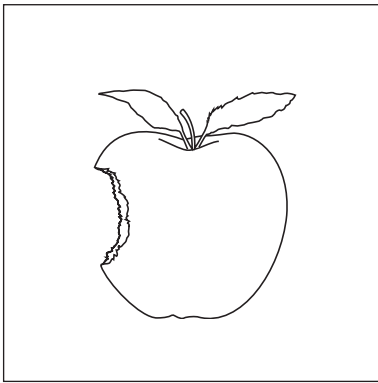

croquer



cueillir



danser

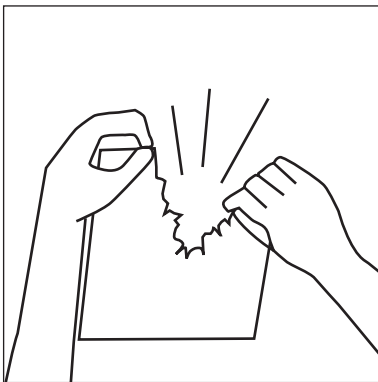

déchirer



déguiser

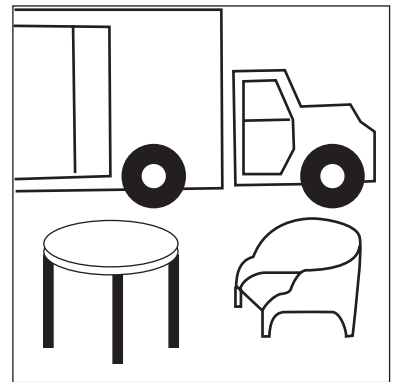

déménager



déprimer

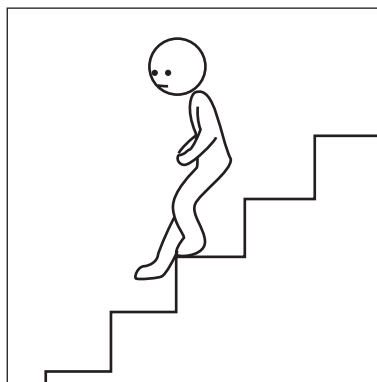

descendre

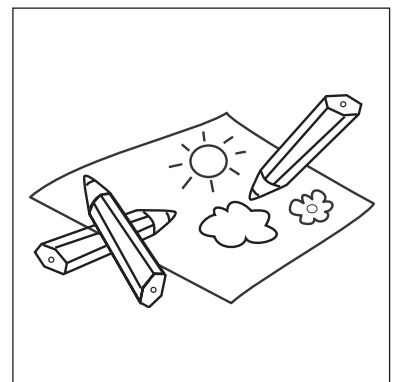

dessiner

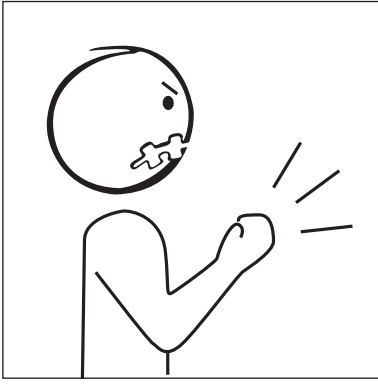

détester

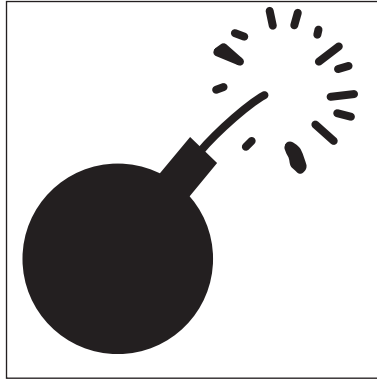

détruire

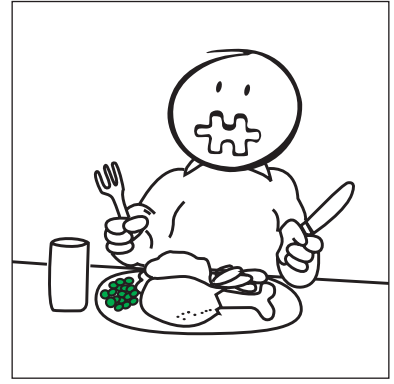

diner, manger

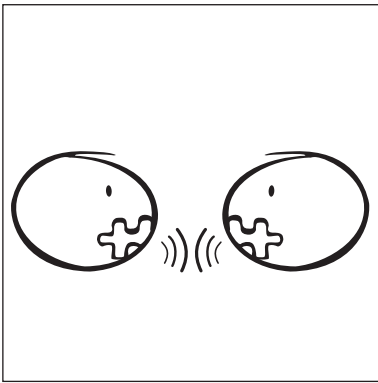

discuter

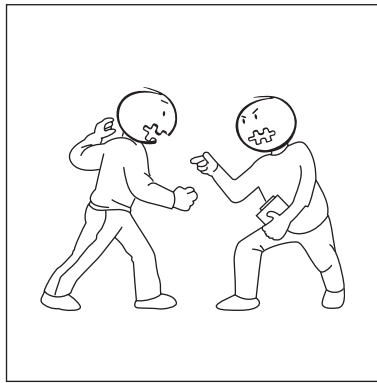

disputer

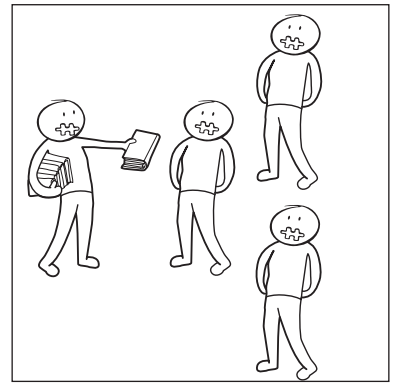

distribuer

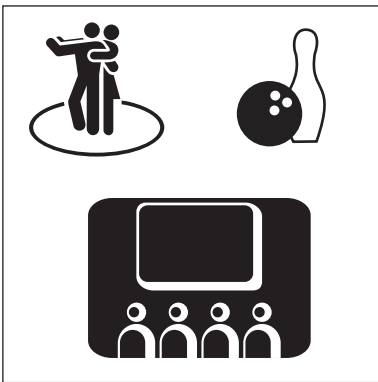

divertir

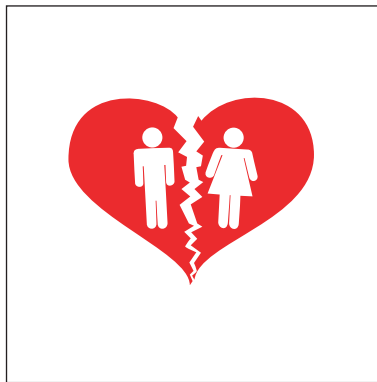

divorcer, séparer

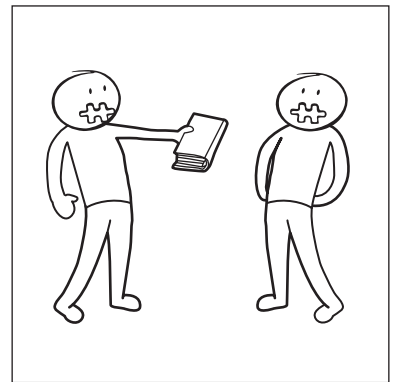

donner

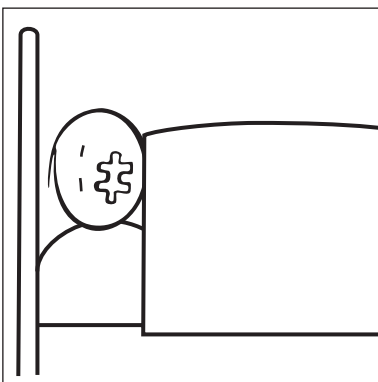

dormir

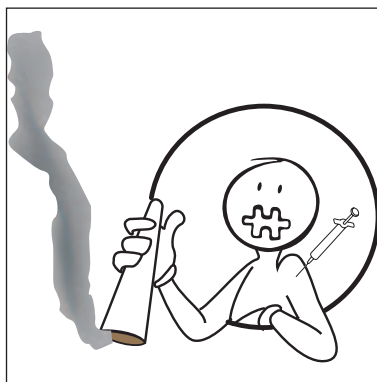

droguer

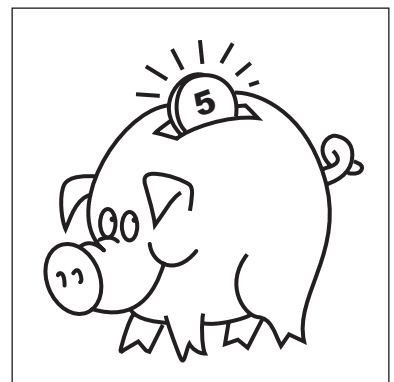

écomoniser

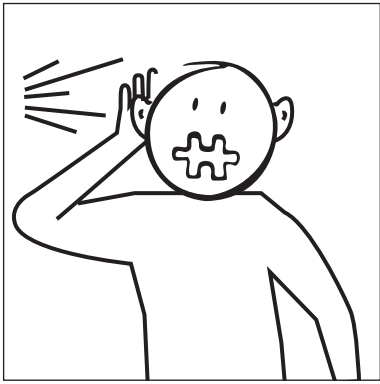

écouter, entendre

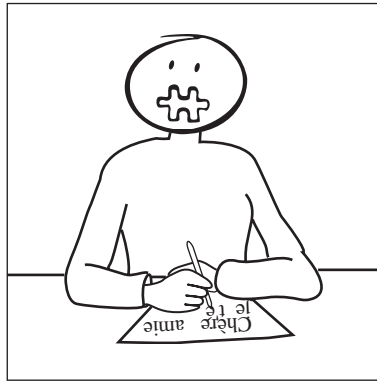

écrire

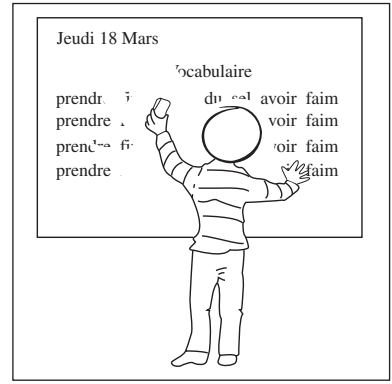

effacer



effrayer, horrifier

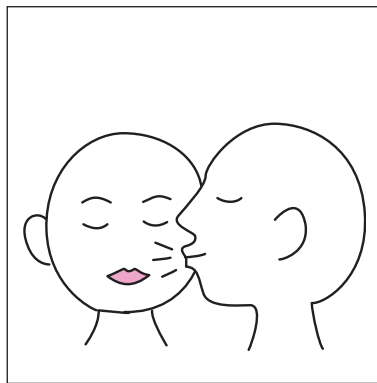

embrasser

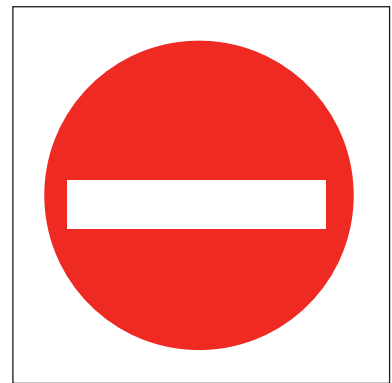

empêcher, interdire



énervé

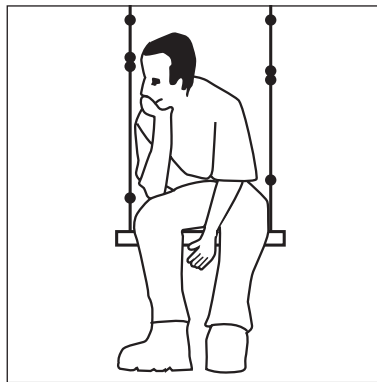

ennuyer

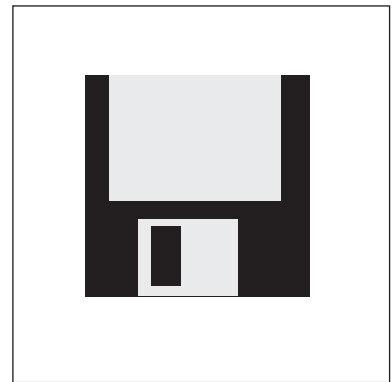

enregistrer



enrhumer

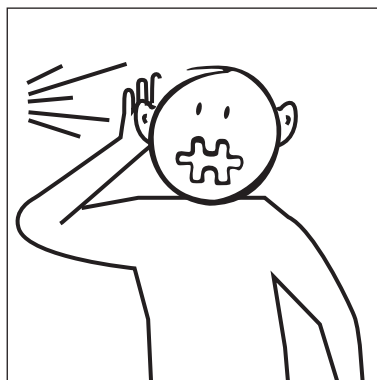

entendre, écouter

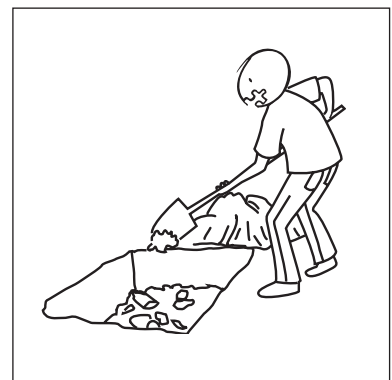

enterrer

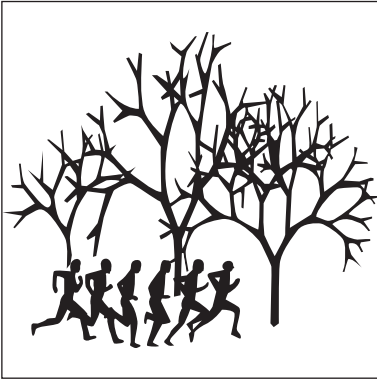

entraîner

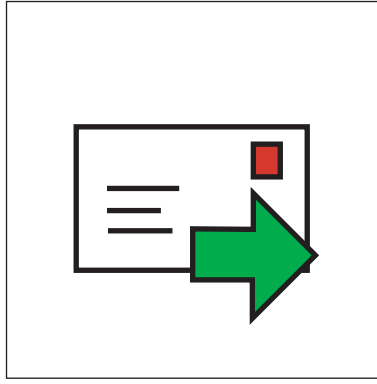

envoyer



épouser, marier

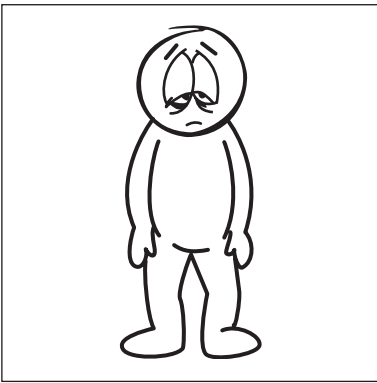

épuiser, fatiguer



escalader

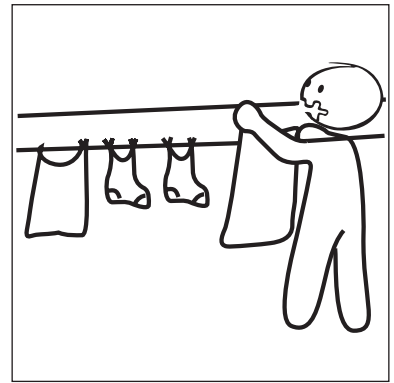

étendre, sécher

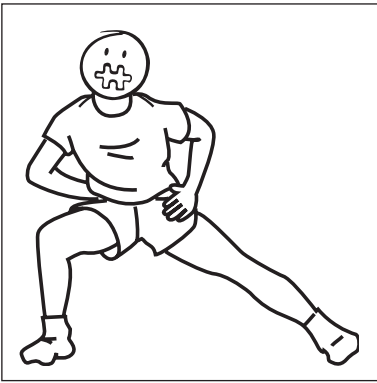

étirer

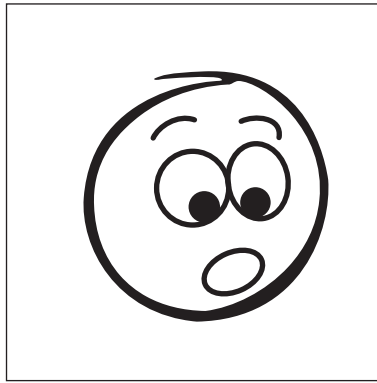

étonner



étouffer

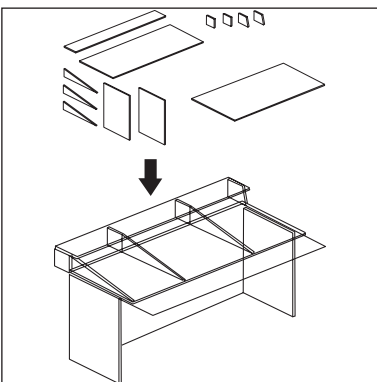

fabriquer, monter

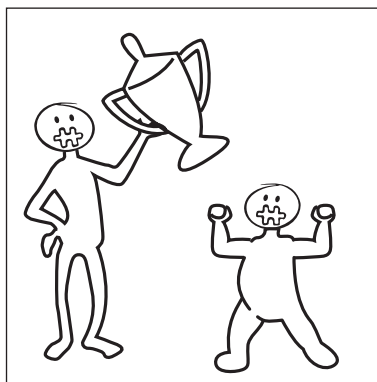

féliciter, gagner

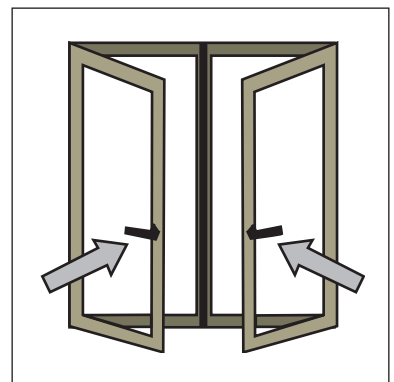

fermer



fêter

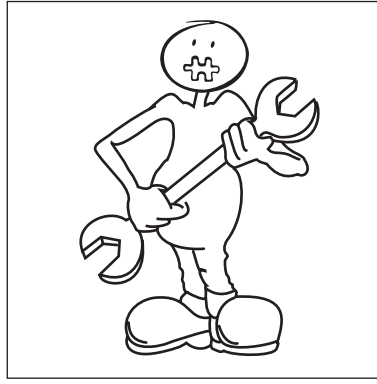

fixer

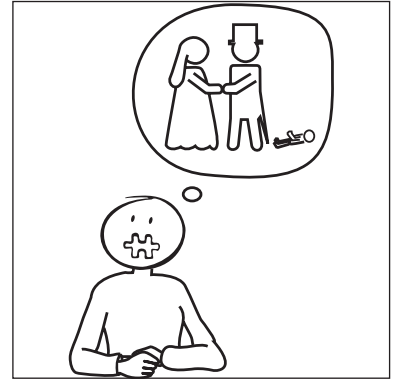

fonder, songer



frapper, taper

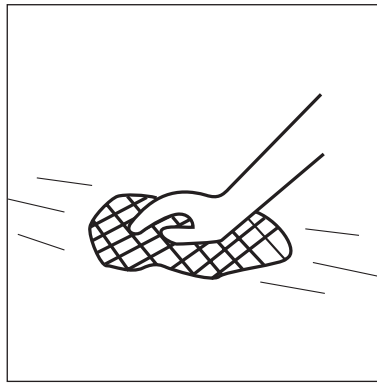

frotter, laver

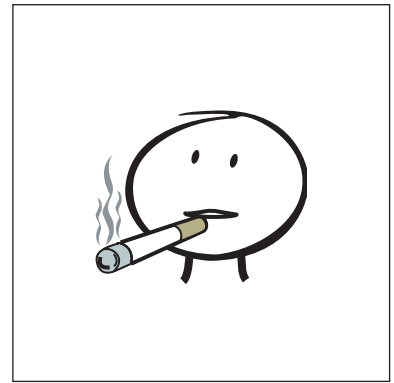

fumer

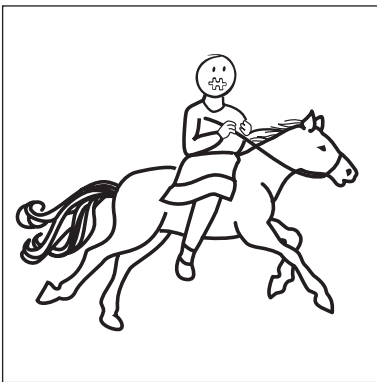

galoper

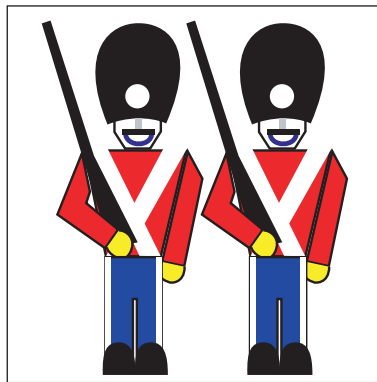

garder

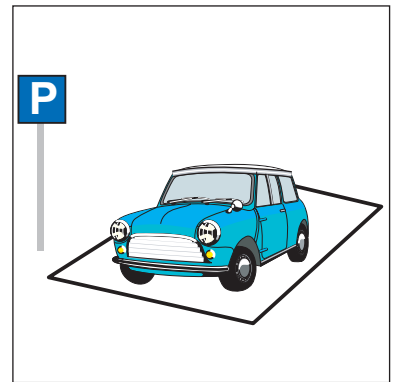

garer

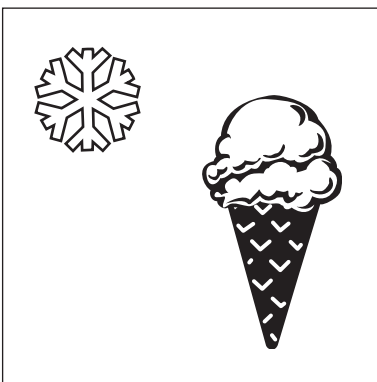

glacer



glisser

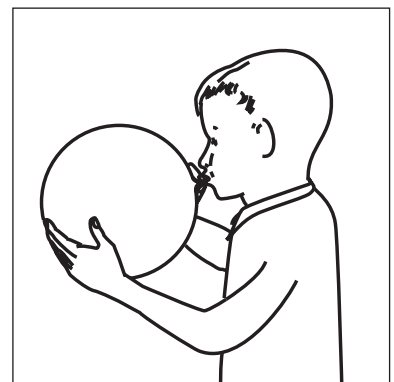

gonfler

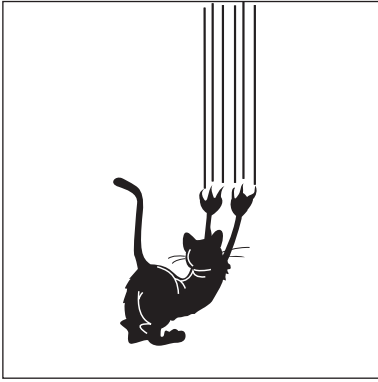

griffer



griller

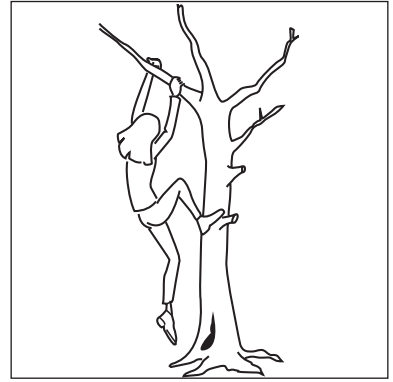

grimper

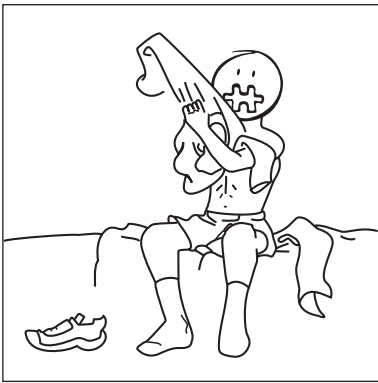

habiller



habiter



handicaper

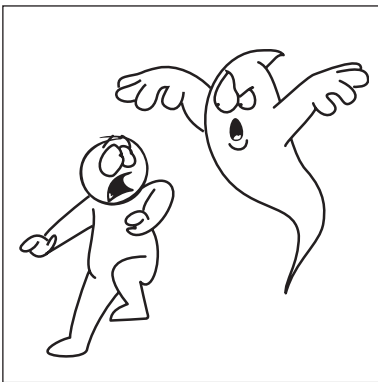

horrifier, effrayer

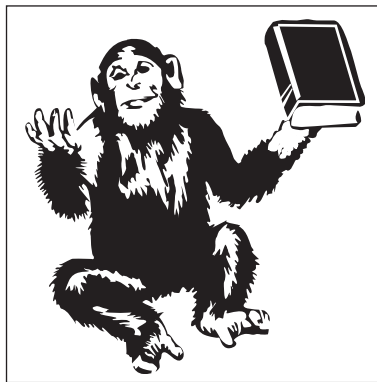

ignorer

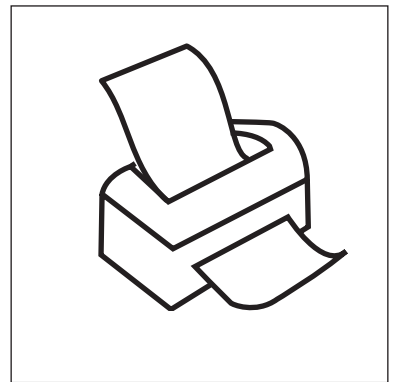

imprimer

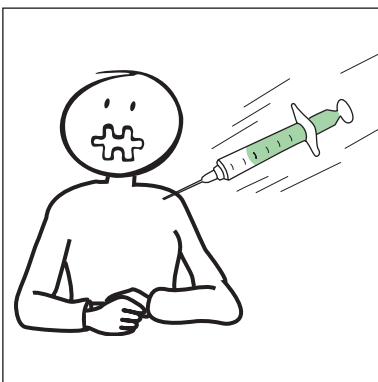

injecter



inquieter

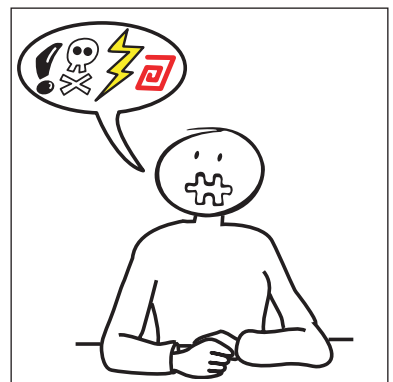

insulter

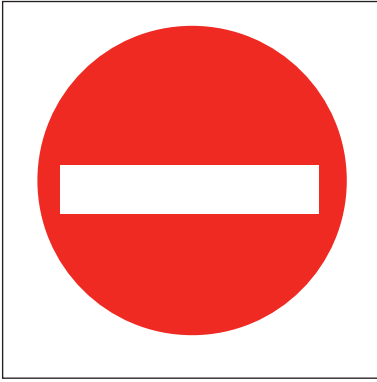

interdire, empêcher

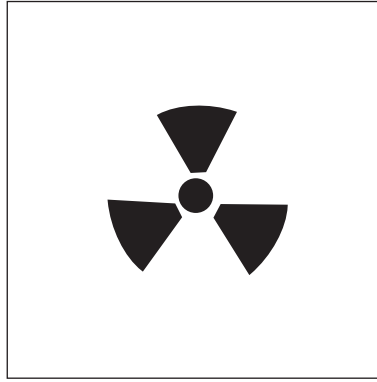

irradier



jardiner

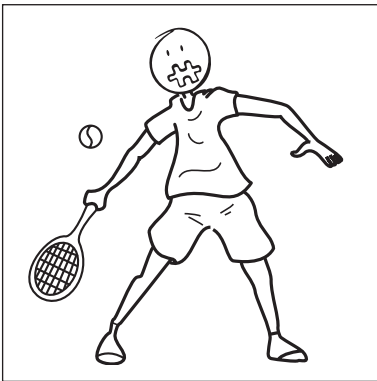

jouer



juger



lacer



lamenter

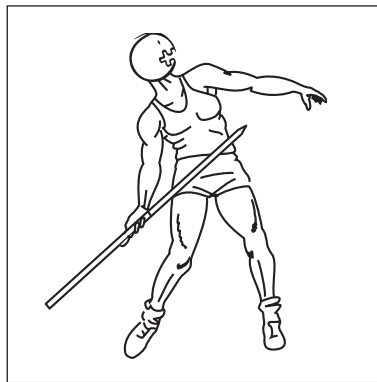

lancer

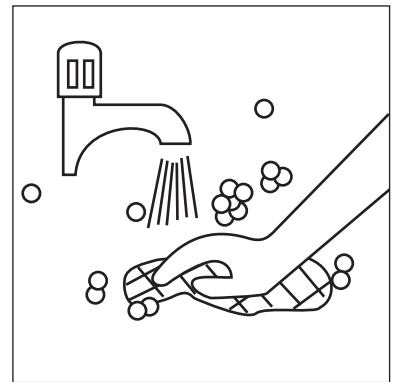

laver

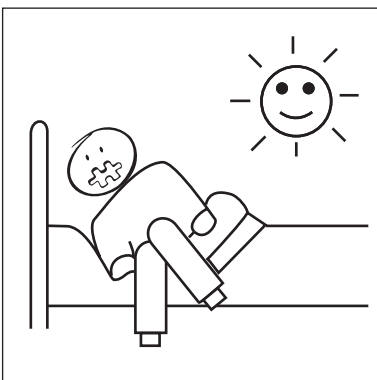

lever



libérer

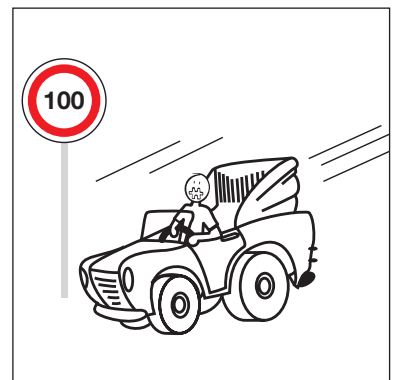

limiter



lire

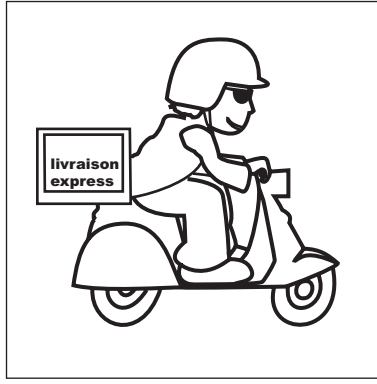

livrer

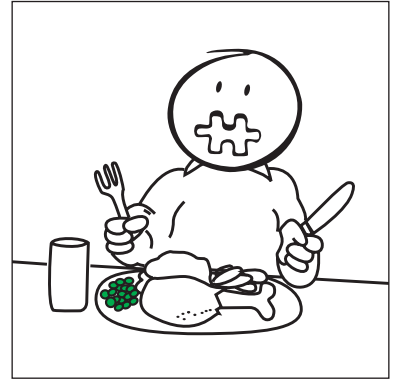

manger, diner

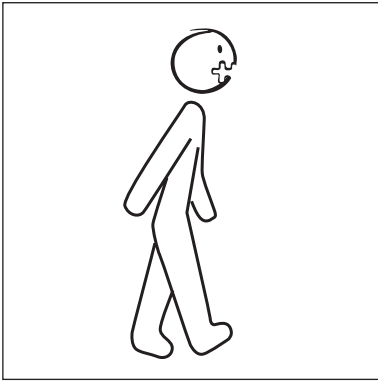

marcher



marier

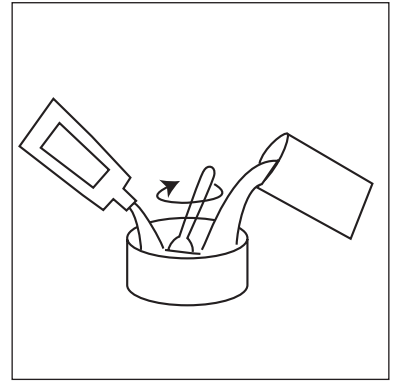

mélanger



mentir

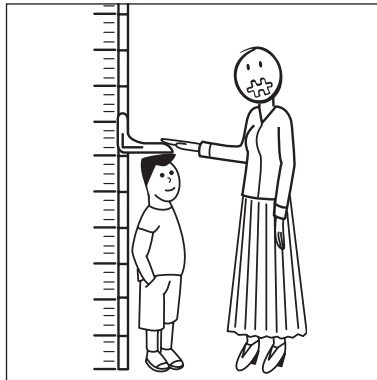

mesurer



mettre



monter

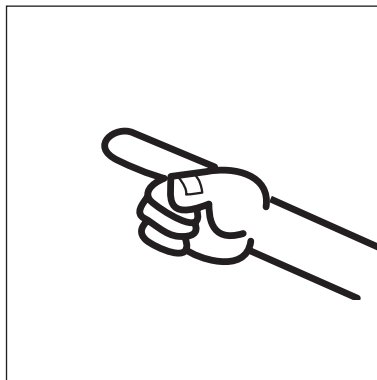

montrer, indiquer

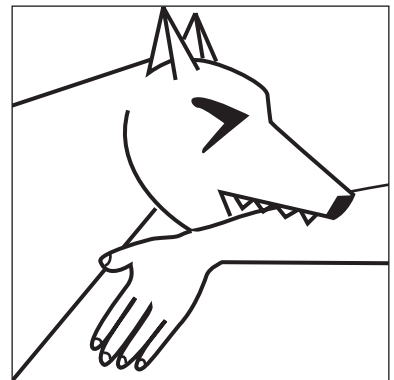

mordre



moucher

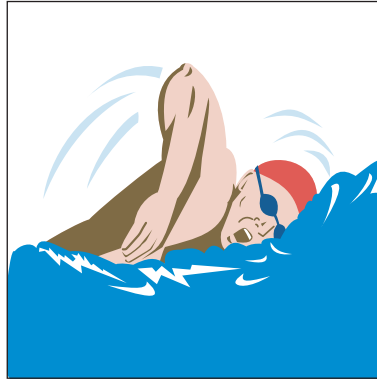

nager



nettoyer

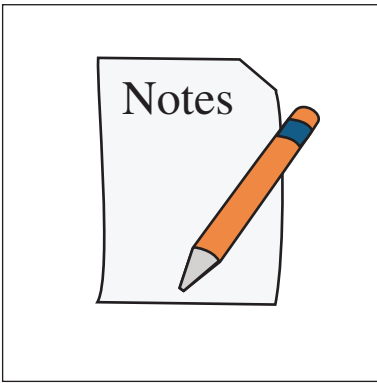

noter



noyer



observer, regarder

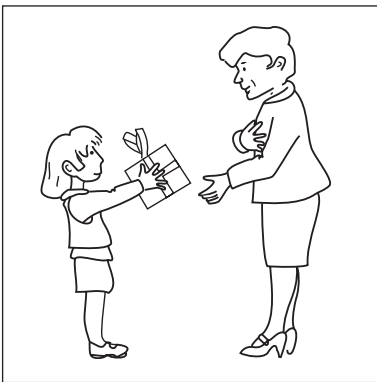

offrir

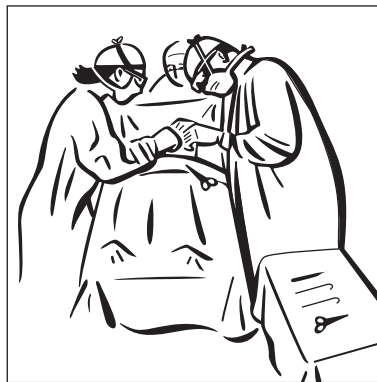

opérer



opposer

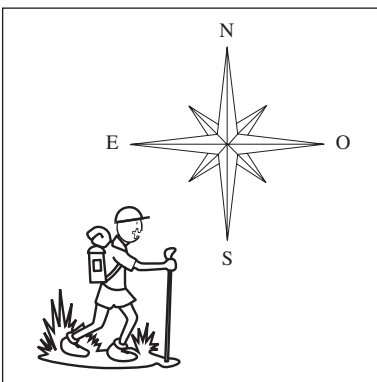

orienter



oublier

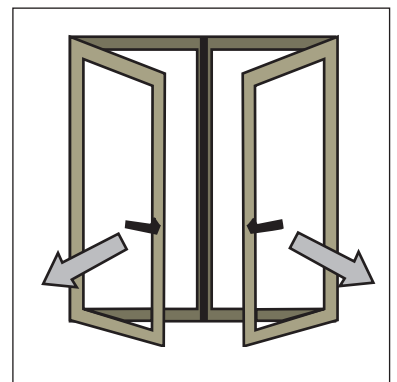

ouvrir

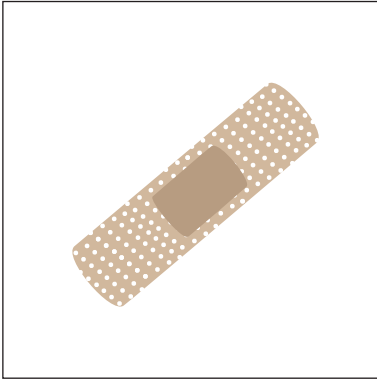

panser



parler

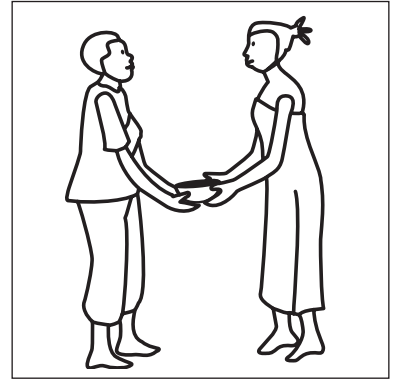

partager

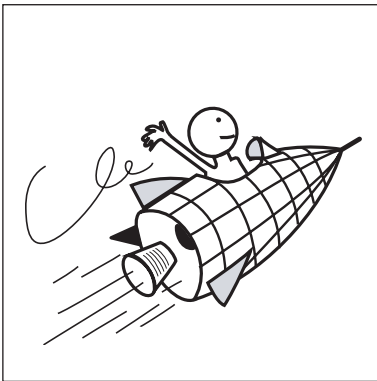

partir

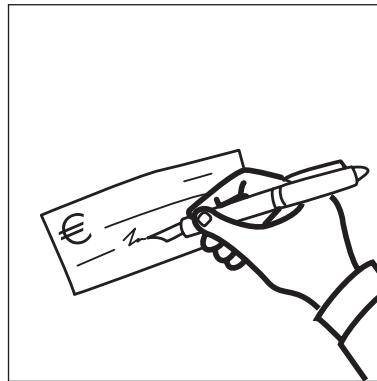

payer

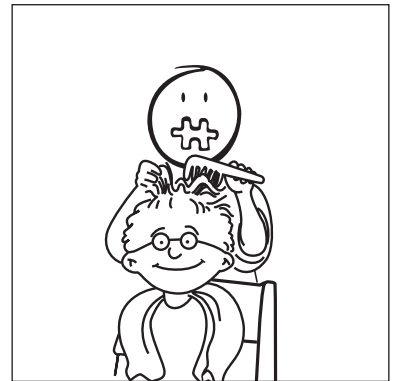

peigner



peindre

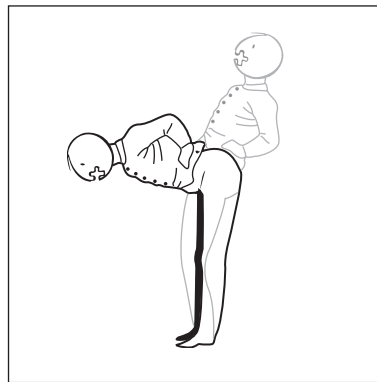

pencher

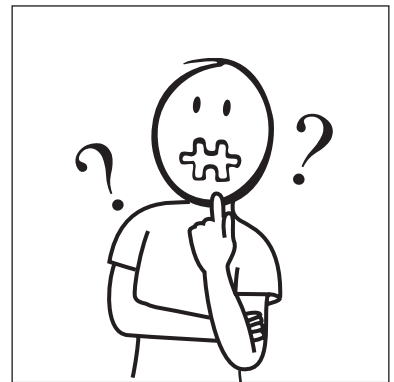

penser, réfléchir

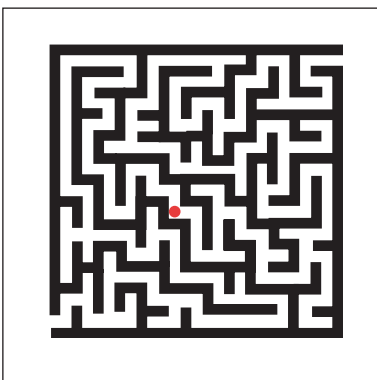

perdre

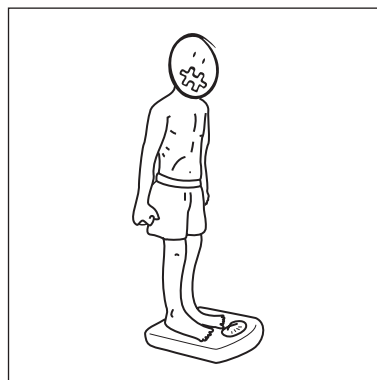

peser

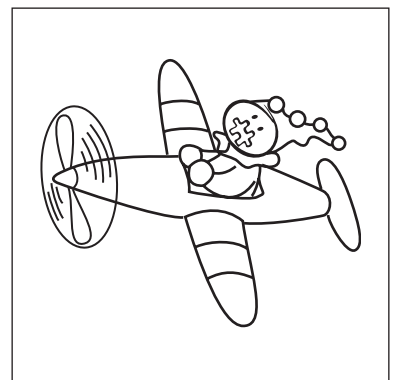

piloter



pincer

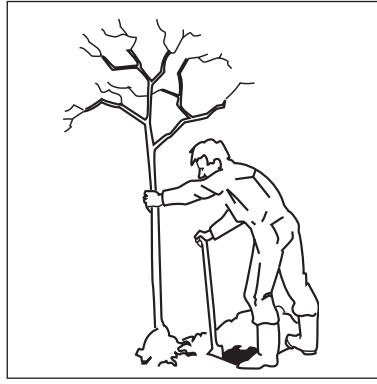

planter

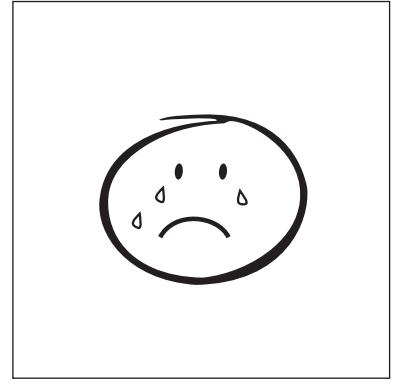

pleurer



pleuvoir

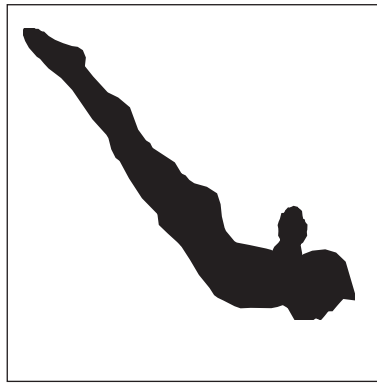

plonger



porter

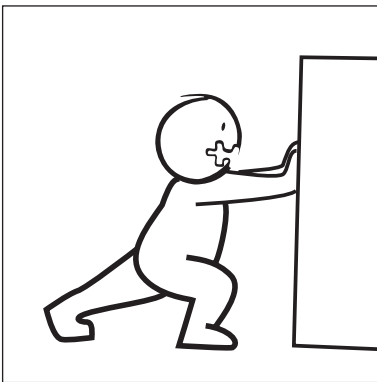

pousser

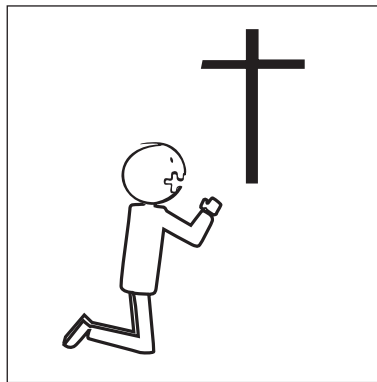

prier

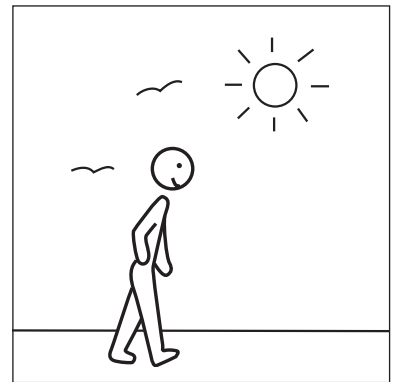

promener



réfléchir, penser



réparer

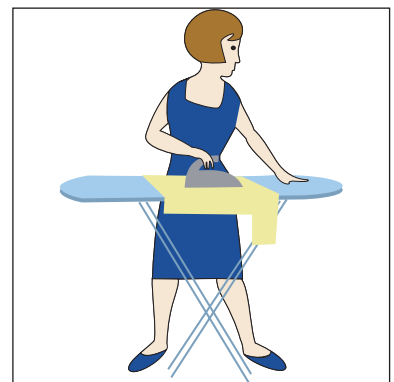

repasser

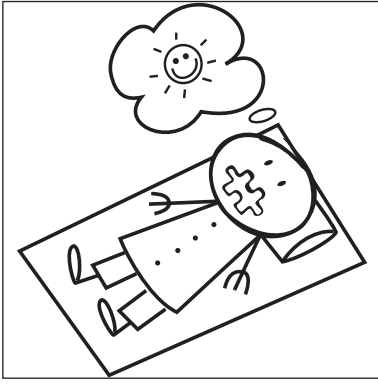

reposer

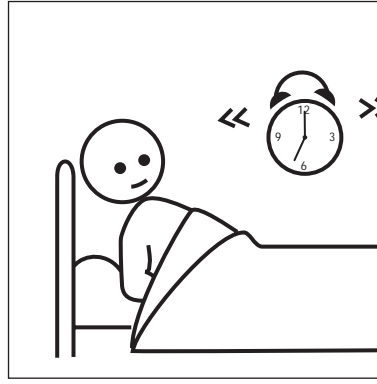

veiller

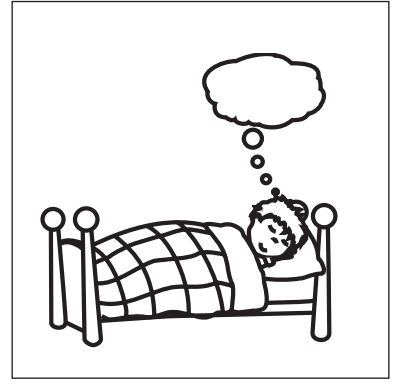

rêver



rire

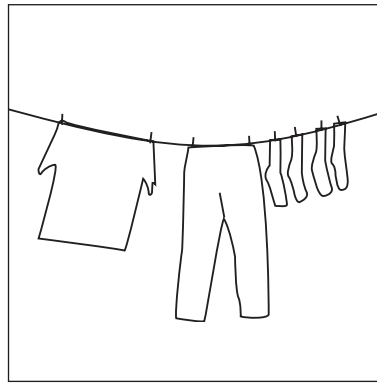

sécher



semer

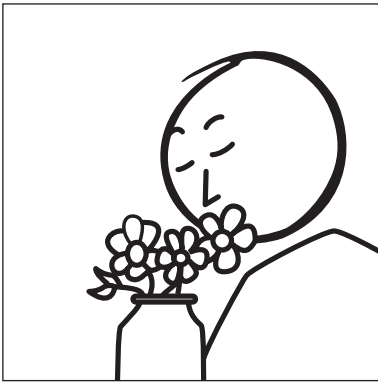

sentir



séparer

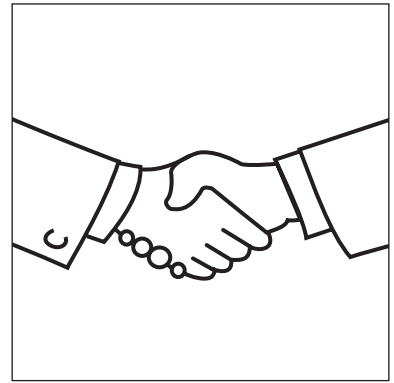

serrer



siffler

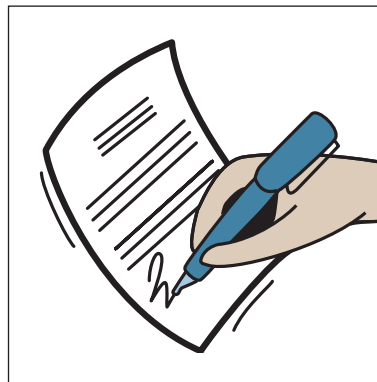

signer

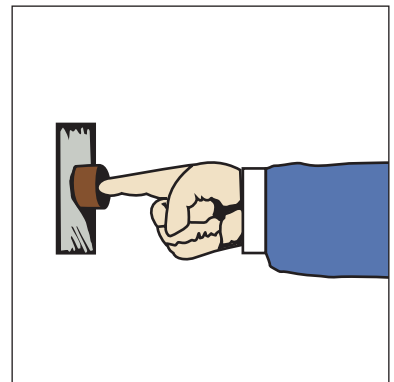

sonner

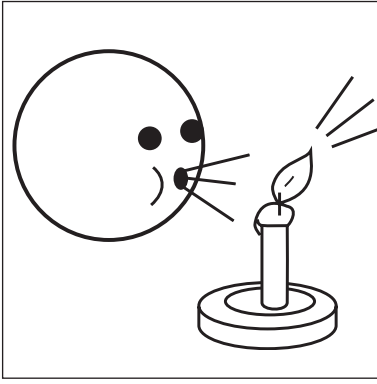

souffler

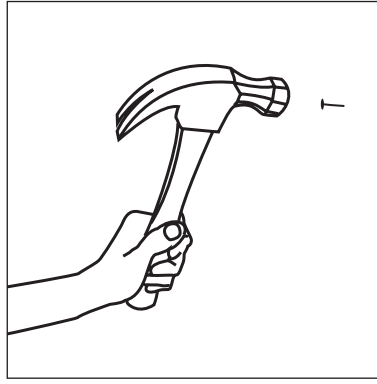

taper

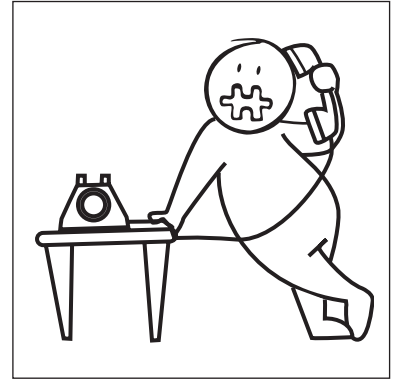

téléphoner

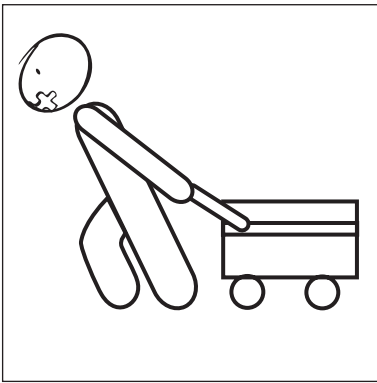

tirer

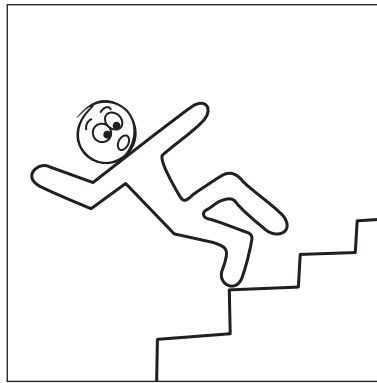

tomber



travailler



trouver

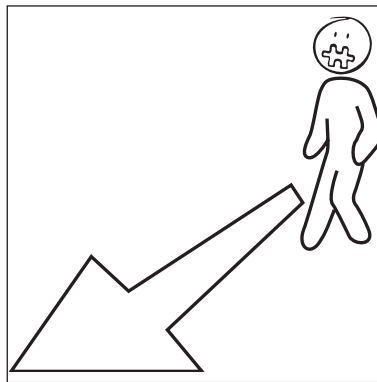

venir

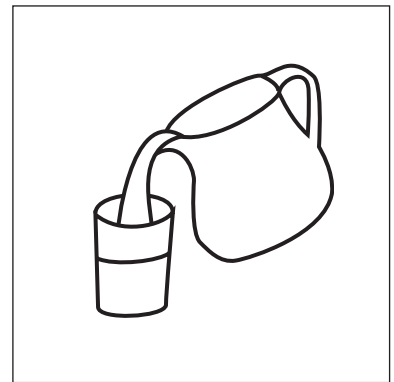

verser

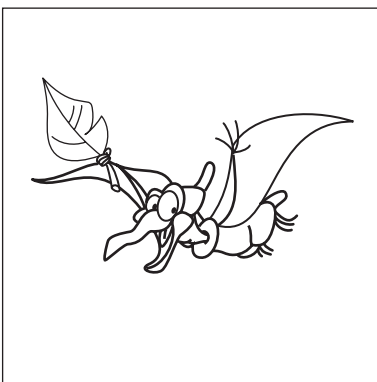

voler

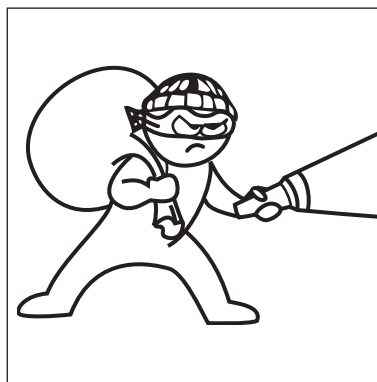

voler

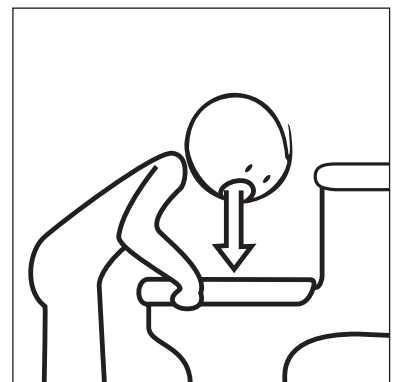

vomir

